

California High-Speed Train Project



TECHNICAL MEMORANDUM

Traction Power 2x25kV Autotransformer Feed Type Electrification System & System Voltages TM 3.1.1.1

Prepared by: Signed document on file _____ 03 March 10
Vinod Sibal, PE, PhD, TPS Manager Date

Checked by: Signed document on file _____ 29 March 10
Richard Schmedes, Systems Manager Date

Approved by: Signed document on file _____ 01 April 10
Ken Jong, PE, Engineering Manager Date

Released by: Signed document on file _____ 06 April 10
Anthony Daniels, Program Director Date

Revision	Date	Description
0	02 May 08	Initial Release
1	26 May 09	Figure 5 revised from metric to U.S. customary units
2	03 Mar 10	Updated the technical terms/abbreviations, Figures 1-6 and definition of single contingency condition.

Note: Signatures apply for the latest technical memorandum revision as noted above.

This document has been prepared by *Parsons Brinckerhoff* for the California High-Speed Rail Authority and for application to the California High-Speed Train Project. Any use of this document for purposes other than this Project, or the specific portion of the Project stated in the document, shall be at the sole risk of the user, and without liability to PB for any losses or injuries arising for such use.

System Level Technical and Integration Reviews

The purpose of the review is to ensure:

- Technical consistency and appropriateness
- Check for integration issues and conflicts

System level reviews are required for all technical memorandums. Technical Leads for each subsystem is responsible for completing the reviews in a timely manner and identifying appropriate senior staff to perform the review. Exemption to the System Level technical and integration review by any Subsystem must be approved by the Engineering Manager.

System Level Technical Reviews by Subsystem:

Systems:	NOT REQUIRED	
	Print Name:	Date
Infrastructure:	NOT REQUIRED	
	Print Name:	Date
Operations:	NOT REQUIRED	
	Print Name:	Date
Maintenance:	NOT REQUIRED	
	Print Name:	Date
Rolling Stock:	<i>Signed document on file</i>	31 March 10
	Frank Banko	Date

Note: Signatures apply for the technical memorandum revision corresponding to revision number in header and as noted on cover.

TABLE OF CONTENTS

ABSTRACT 1

1.0 INTRODUCTION 2

1.1 PURPOSE OF TECHNICAL MEMORANDUM 2

1.2 STATEMENT OF TECHNICAL ISSUE 2

1.3 GENERAL INFORMATION 2

 1.3.1 DEFINITION OF TERMS 2

 1.3.2 UNITS 4

2.0 DEFINITION OF TECHNICAL TOPIC..... 5

2.1 CHSR LINE DESIGN CONSIDERATIONS..... 5

2.2 CHSR LINE DESIGN PARAMETERS 5

3.0 ASSESSMENT / ANALYSIS..... 6

3.1 GENERAL..... 6

3.2 ASSESSMENT 6

 3.2.1 ANALYSIS 6

 3.2.2 APPLICABILITY TO U.S. STANDARDS..... 7

4.0 SUMMARY AND RECOMMENDATIONS 8

5.0 SOURCE INFORMATION AND REFERENCES..... 8

6.0 DESIGN MANUAL CRITERIA 9

6.1 AUTOTRANSFORMER FEED TYPE ELECTRIFICATION SYSTEM FOR INCLUSION IN DESIGN MANUAL 9

ABSTRACT

The California High-Speed Rail (CHSR) Line will be an Electrified Line with Traction Power for Electric Vehicles being supplied and distributed using a 2x25kV Autotransformer Feed Type Power Supply System and an Overhead Contact System.

The purpose of this technical memorandum is to:

- Provide the basis for the choice of a 2x25kV Autotransformer Feed Type System over other Electrification Systems.
- Describe the configuration of the 2x25kV Autotransformer Feed Type System.
- Provide guidelines for the Utility Power Supplies to the Traction Power Substations.
- Provide guidelines for the basic configuration and location of the Traction Power Substations, Switching Stations and Paralleling Stations.
- Provide the Design Manual Criteria for the Traction Power Facilities for a 2 x 25kV Autotransformer Feed Type System.
- Provide the Design Manual Criteria for the 2x25kV Autotransformer Feed Type System Voltage levels.

Development of the Design Criteria for the 2x25kV Autotransformer Feed Type traction power supply system and its operating voltages will include, but not be limited to, the following:

- The general configurations of the traction power supply feeding and return systems for the 2x25kV Autotransformer Feed Type System (Single Line Diagrams).
- Criteria for the Utility Supply Circuits to Traction Power Substations.
- The provisional layout of the major equipment in each type of Traction Power Facility.
- The Nominal System Operating Voltage.
- The Maximum and Minimum Long Term System Operating Voltages.
- The Maximum and Minimum Short Term System Operating Voltages.

Note:

- (i) The Design Criteria for the Traction Power Facilities and access for each type of facility will be provided in a separate technical memorandum.
- (ii) The Design Criteria for the equipment layout, metering and protection for each type of traction power facility will be provided in a separate technical memorandum.
- (iii) The Design Criteria for the Overhead Contact System, Negative Feeders, Rail Return and Grounding will be provided in a separate technical memorandum.
- (iv) The detailed requirements for the Utility Supply Circuits will be provided in a separate technical Memorandum.

1.0 INTRODUCTION

There are four basic technical issues covered in this technical memorandum:

1. The choice of Traction Power Supply System for the CHSR Line, 1x 25kV (Standard Transformer) or 2 x 25kV (Autotransformer Feed Type).
2. The Number of Utility Supply Circuits for each Traction Power Substation.
3. The configuration of the OCS and Negative Feeder Supply Circuits, and rail Return Circuits for each Type of Traction Power Facility.
4. The Nominal System Voltage, and the acceptable Minimum and Maximum System Voltages.

1.1 Purpose of Technical Memorandum

The purpose of this technical memorandum is to provide the basic configuration of the Traction Power Supply System for the CHSR Line, the guidelines for the Utility Supply to the Traction Power Substations, and the acceptable System Voltage levels that will support the proposed level of service.

1.2 STATEMENT OF TECHNICAL ISSUE

The following Technical issues will be discussed:

1. The choice of Traction Power Supply System, 1 x 25kV (Standard Transformer) or 2 x 25kV. (Autotransformer Feed Type).
2. The number of Utility Supply circuits for each Traction Power Substation, (Redundant Utility Supply).
3. The Configuration of the OCS and Negative Feeder Supply Circuits and the Rail Return Circuits.
4. The Maximum and Minimum OCS Voltage levels that will be permitted.

1.3 GENERAL INFORMATION

The CHSR Line will have an end-to-end length of nominally 800 miles. It will be designed and built in segments, possibly by different entities, over a number of years. Although the Civil and Structural elements of the line may vary in the different segments, the "Systems" elements must be consistent over the full length of the line.

This technical memorandum will provide the basic information and criteria for the Traction Power Supply System and the acceptable voltage levels. This information is applicable to all main Line segments of the CHSR Line.

1.3.1 Definition of Terms

The following technical terms, acronyms, phrases, and terminology have specific connotations with regard to Traction Power Supply Systems the California High Speed Train Line:

- Technical Terms

Autotransformer (AT): Apparatus which serves to reduce current in traction power conductors on CHSR electrification system. It uses a single winding having three terminals. The intermediate terminal is connected to the rail and its position determines the catenary to rail voltage. The other two terminals are connected to the catenary and feeder wires.

Negative Feeder (NF): Negative feeder is an overhead conductor supported on the same structure as the OCS, and is at a voltage of 25 kV with respect to ground but 180⁰ out-of-phase with respect to the voltage on the OCS. Therefore the voltage between the OCS and the negative feeder is 50 kV nominal. The negative feeder connects successive

feeding points, and is connected to one terminal of an autotransformer in the traction power facilities via a circuit breaker or disconnect switch. At these facilities, the other terminal of the autotransformer is connected to a catenary section or sections, via circuit breakers or disconnects.

Power Transformer: A device which transforms power on an AC system from one voltage level to another (e.g., from 115 kV to 25 kV).

Traction Power Facilities (TPF): A general term that encompasses substations (SS), switching stations (SWS) and paralleling stations (PS).

Traction Power Supply System (TPS): The railway electrical distribution network used to provide energy to high-speed electric trains, which comprises of the following three types of traction power facilities in addition to connections to the OCS and the traction return and earthing system:

1. Substation (SS) at which power is converted from high voltage to a nominal 2X25 kV railway traction voltage and distributed to the Overhead Contact System (OCS), including incoming high voltage (115/230/500 kV) supplies, from power supply utility's network,
2. Switching Station (SWS): An installation at which electrical energy can be distributed to different feeding sections or from where different feeding sections can be energized, de-energized, isolated or interconnected. The negative feeders and the catenary conductors are also connected to the autotransformers at this location. , and
3. Paralleling Station (PS): An installation at which OCS sections can be connected in parallel. The negative feeders and the catenary conductors are also connected to the autotransformers at this location.

Abbreviations:

ac	Alternating Current
ACSR	Aluminium Conductor Steel Reinforced
AEC	Aerial Earth (Ground) Conductor
AT	Autotransformer
BEC	Buried Earth (Ground) Conductor
CHSRA	California High Speed Rail Authority
CHSTP	California High Speed Train Project
CPUC	California Public Utility Commission
Cu	Copper
CW	Contact Wire
dc	Direct Current
EMC	Electro Magnetic Compatibility
EMI	Electro Magnetic Interference
HV	High Voltage
IMP	Impedance Bond
LV	Low Voltage
MW	Messenger Wire
NF	Negative Feeder
NIST	National Institute of Standards and Technology
OCS	Overhead Contact System
PS	Paralleling Station (with Autotransformer)
SS	Traction Power Substation (with HV Utility Supply)
SWS	Switching Station (with Autotransformers)
TES	Traction Electrification System
TPF	Traction Power Facilities
TPS	Traction Power Supply System

1.3.2 Units

The California High-Speed Train Project (CHSTP) is based on U.S. Customary Units consistent with guidelines prepared by the California Department of Transportation and defined by the National Institute of Standards and Technology (NIST). U.S. Customary Units are officially used in the United States, and are also known in the US as “English” or “Imperial” units. In order to avoid any confusion, all formal references to units of measure should be made in terms of U.S. Customary Units.

Guidance for units of measure terminology, values, and conversions can be found in the Caltrans Metric Program Transitional Plan, Appendice B U.S. Customary General Primer (<http://www.dot.ca.gov/hq/oppd/metric/TransitionPlan/Appendice-B-US-Customary-General-Primer.pdf>). Caltrans Metric Program Transitional Plan, Appendice B can also be found as an attachment to the CHSTP Mapping and Survey Technical Memorandum.

2.0 DEFINITION OF TECHNICAL TOPIC

The following sections contain the Design Considerations that were assessed in determining the type of Traction Power Supply System to be used for the CHSR Line, and the existing Design Parameters that the selected System must meet. A description of the Design Parameters may be found in the California High-Speed Train Project “Basis of Design” report.

2.1 CHSR Line Design Considerations

- The Ultimate Level of Service to be supported by the Traction Power Supply System
- The level of service to be maintained during Contingency Power Supply Conditions
- Location and available capacity of existing HV Utility Circuits
- Location and availability of sites for Traction Power Substations
- EMI and EMC aspects of the Traction Power Supply System
- Rail Vehicle Operating Voltage criteria

2.2 CHSR Line Design Parameters

- Nominal System Voltage 25.0 kV
- Maximum Long Term Voltage 27.5 kV
- Maximum Short Term Voltage 29.0 kV
- Minimum Long Term Voltage 19.0 kV
- Minimum Short Term Voltage 17.5 kV
- Minimum Supply Voltage for Utility Circuits 115 kV at SS
- Redundant Utility Supply Circuits at SS (two independent 3 phase Circuits originating from two different Utility Bus Systems.)
- Redundant Power Supply Transformers at SS (two HV Transformers each rated for the Full Load of the SS with Switchgear configured to allow either Utility Supply Circuit to supply either or both Transformers.)
- No degradation of train performance during Single Contingency Power Supply conditions (the loss of a Single Utility Supply Circuit, or a Single Item of equipment, or a Single Negative Feeder, or a Single Rail Return Circuit.)
- No stranded trains during Second Contingency Power Supply Conditions (the concurrent loss of any two of the above, in any combination.)

3.0 ASSESSMENT / ANALYSIS

3.1 GENERAL

The two most common Electrification Power Supply Systems for High Speed Rail and Commuter Rail Lines are:

- 1 x 25 kV Systems
- 2 x 25kV Autotransformer Feed Type Systems

Both Systems receive power from High Voltage, 60 Hertz, 3 Phase Utility Circuits and both Systems provide 25kV, 60 Hertz, Single Phase Power to the Overhead Contact System.

To ensure that power is not lost to an entire SS as a result of a Single Contingency occurrence both Systems utilize redundant Utility Power Supply Circuits and redundant HV Transformers.

1 x 25 kV Systems utilize Traction Power Substations with Standard Power Supply Transformers which provide Power at 25kV to the Overhead Contact System (See Figure 1).

2 x 25kV Autotransformer Feed Type Systems utilize Traction Power Substations with Main Transformers, and Switching Stations and Paralleling Stations, both with Autotransformers, which provide 25kV (nominal) voltage to the Overhead Contact System with respect to Ground and also 25kV to along-track Negative Feeders with respect to Ground. Both of these voltages are at 180° out-of-phase with each other, and hence, the Overhead Contact System is at 50 kV with respect to the Negative Feeders (See Figures 2, 3 & 4).

3.2 ASSESSMENT

3.2.1 Analysis

Although 1 x 25kV Traction Power Supply Systems were used successfully for Electrified Main Line Railroads for many years (See Figure 1), 2 x 25kV Autotransformer Feed Type Traction Power Supply Systems have become the modern “Standard” for Main Line Electrification, especially for high-speed lines. The 2 x 25kV configuration utilizes Autotransformers to supply (+)25kV to the OCS and (-)25kV to the Negative Feeders, essentially providing a “boost” to the voltage on the Overhead Contact System and extending the reach of the Substations (See Figures 2, 3 & 4).

In total there are more Traction Power Facilities required for a 2 x 25kV Autotransformer Feed Type System than for a 1 x 25kV System, but there are fewer Substations, with their associated HV Utility Circuits, HV Transformers and HV Switchgear - this is a major advantage (See Figure 5).

A further benefit of the 2 x 25kV Autotransformer Feed Type System is that the Electromagnetic Interference (EMI) emitted due to the load current in the OCS and Running Rails is considerably reduced. Autotransformers inherently attempt to equalize the current flowing in the two sections of the transformer windings. For Autotransformers that are supplying a heavy OCS Load Current the net effect is that Traction Power Return Current in the Running Rails is drawn through the Autotransformer's (-) 25kV winding and into the Negative Feeder in order to create the required balance (See Figure 6).

Due to this Autotransformer effect the current in the running rails is much reduced between the train and the remote Autotransformer feeding the Electrical Section, and very much reduced in the adjacent Electrical Sections.

Since the EMI caused by the supply and return current loop is proportional to the Field created by the magnitude of the current in the loop and the size of the loop then reducing either will reduce the level of EMI generated.

A comparison of the extent of the electromagnetic field created by the load and return currents for a 1 x 25kV System and a 2 x 25kV Autotransformer Feed Type System is shown in Figure 7. The field for the 2 x 25kV Autotransformer Feed Type System illustrates the “ideal” condition where the running rail current is very small, compared to the load current, and nearly all of the return current is flowing in the Negative Feeder. From Figure 7 it can be seen the extent of the EMI in the 2 x 25kV case is much reduced and would therefore have a lesser effect on other Systems and equipment either on-board the vehicles or at ground level.

3.2.2 Applicability to U.S. Standards

At this time there are no specific North American Federal or State of California standards or criteria for 25KV 60 Hertz Autotransformer Feed Type Electrification Systems.

4.0 SUMMARY AND RECOMMENDATIONS

From the assessment above it can be determined that the selection of a 2 x 25kV Autotransformer Feed Type Power Supply System, as opposed to a 1 x 25kV System, for the CHSR Line will have the following advantages:

1. The number of Traction Power Substations requiring HV Utility Supply Circuits, HV Transformers and HV Switchgear will be less.
2. The extent of the EMI generated by the load and return currents will be reduced.

Offsetting disadvantages are:

1. The total number of Traction Power Facilities will be higher; however, the added Traction Power Facilities will be smaller in size and will not require HV Utility supply circuits or HV Equipment.
2. The System will require an along-track Negative Feeder, and the OCS support structures must be capable of supporting the added load of this feeder.

Based on the above, a 2 x 25kV Autotransformer Feed Type Power Supply System is recommended for the CHSR Line.

The recommendation to use a 2 x 25kV Autotransformer Feed Type Power Supply and Distribution System will affect the following Groups and/or Disciplines:

- Traction Power Design (Preliminary Engineering, Standard Drawings, Criteria)
- OCS Design (Preliminary Engineering, Standard Drawings, Criteria)
- Segment Designers (Design Development, Supply Station Sites, HV Utility Supplies)

Following confirmation of the selection of a 2 x 25kV Autotransformer Feed Type Power Supply System for the CHSR Line, the design of the Traction Power Facilities and Power Distribution System will be progressed to the Preliminary Engineering level.

In addition, as Rail Vehicle, Alignment and Operating details are developed Computer Simulations will be performed to both size power supply equipment and indicate locations for the Traction Power Facilities along the railroad right-of-way.

5.0 SOURCE INFORMATION AND REFERENCES

The following Electrification Systems were analyzed during the assessment of the merits of a 2 x 25kV Autotransformer Feed Type Power Supply System for the CHSR Line:

- The French TGV System
- The Japanese Shinkansen System
- The Taiwan HSR System
- The Amtrak NEC (Boston to New Haven Line)
- The NJT Morris & Essex Lines
- The Proposed CALTRAIN San Jose to San Francisco Line

6.0 DESIGN MANUAL CRITERIA

6.1 AUTOTRANSFORMER FEED TYPE ELECTRIFICATION SYSTEM FOR INCLUSION IN DESIGN MANUAL

- The Traction Power Supply System (TPS) for the CHSR Line will be a 2 x 25kV Autotransformer Feed Type System.
- HV Utility Supply Voltage for the Traction Power Substations will be 115kV or higher.
- Each Traction Power Substation will have redundant HV Utility Supply Circuits originating from different Utility Bus Systems.
- Each Traction Power Substation will have redundant Main Power Transformers each sized for the Ultimate full-load of the Substation.
- Each Traction Power Substation will have HV Switchgear configured to allow either Utility Circuit to supply either or both HV Transformers.
- Traction Power Substations, Switching Stations and Paralleling Stations will be rated and located in accordance with the findings of the traction power computer load-flow simulations for the Ultimate load on the System.
- Ratings and configuration for each type of Traction Power Facility will be standardized as much as is feasible.
- The Nominal System Voltage for the Traction Power Supply System is 25kV
- The Maximum permissible Long-Term (and No-Load) Voltage for the TPS is 27.5kV.
- The Maximum permissible Short-Term Voltage of the TPS is 29kV
- The Minimum permissible Long-Term Voltage for the TPS is 19kV.
- The Minimum permissible Short-Term Voltage for the TPS is 17.5kV
- There must be no degradation of Train Performance during First Contingency Power Supply conditions.
- There must be no stranding of Trains during Second Contingency Power Supply Conditions.

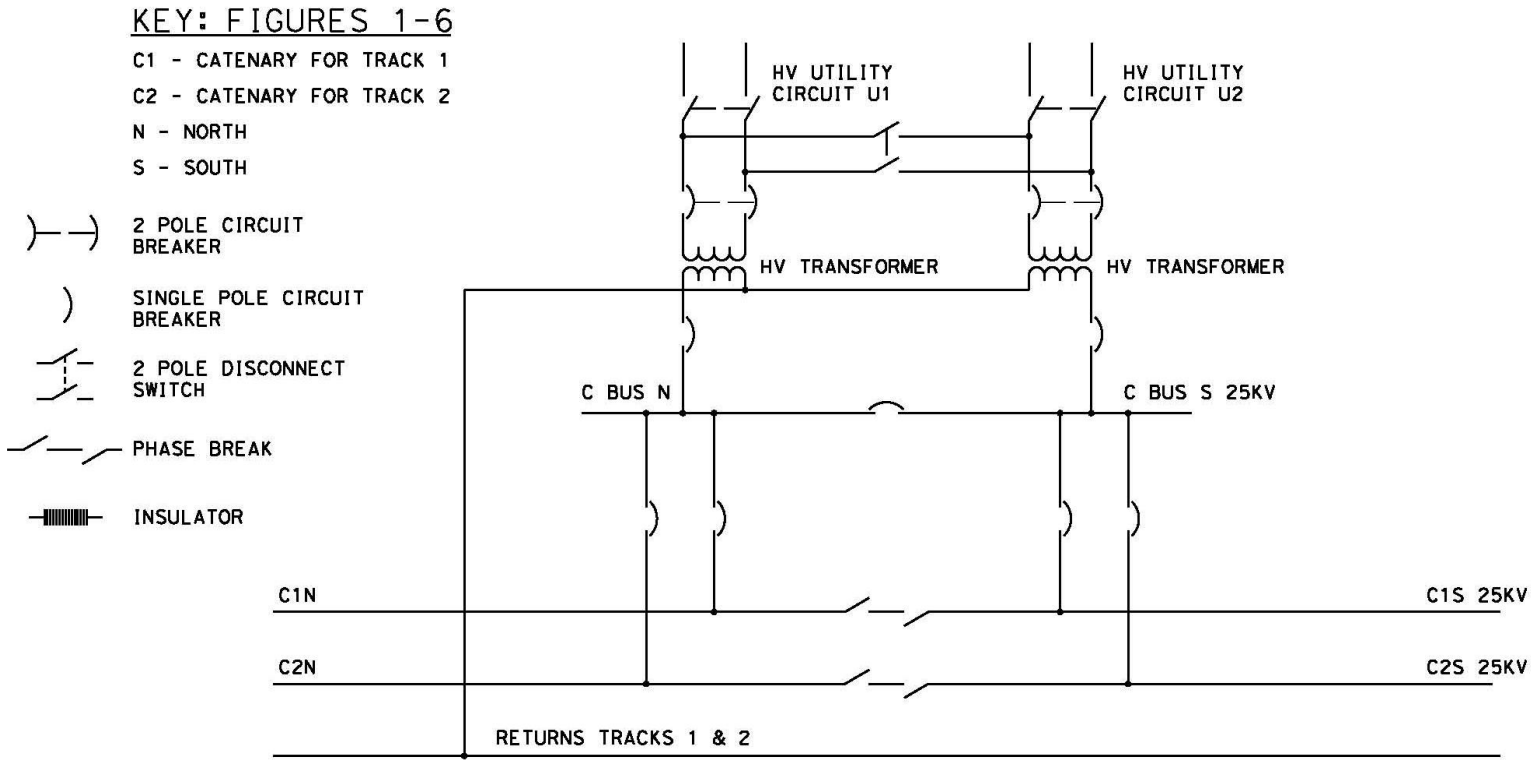

TRACTION POWER SUBSTATION WITH UTILITY SUPPLY - 1X25KV SYSTEM

FIGURE 1

- C1 - CATENARY FOR TRACK 1
- C2 - CATENARY FOR TRACK 2
- F1 - NEGATIVE FEEDER FOR TRACK 1
- F2 - NEGATIVE FEEDER FOR TRACK 2
- N - NORTH
- S - SOUTH

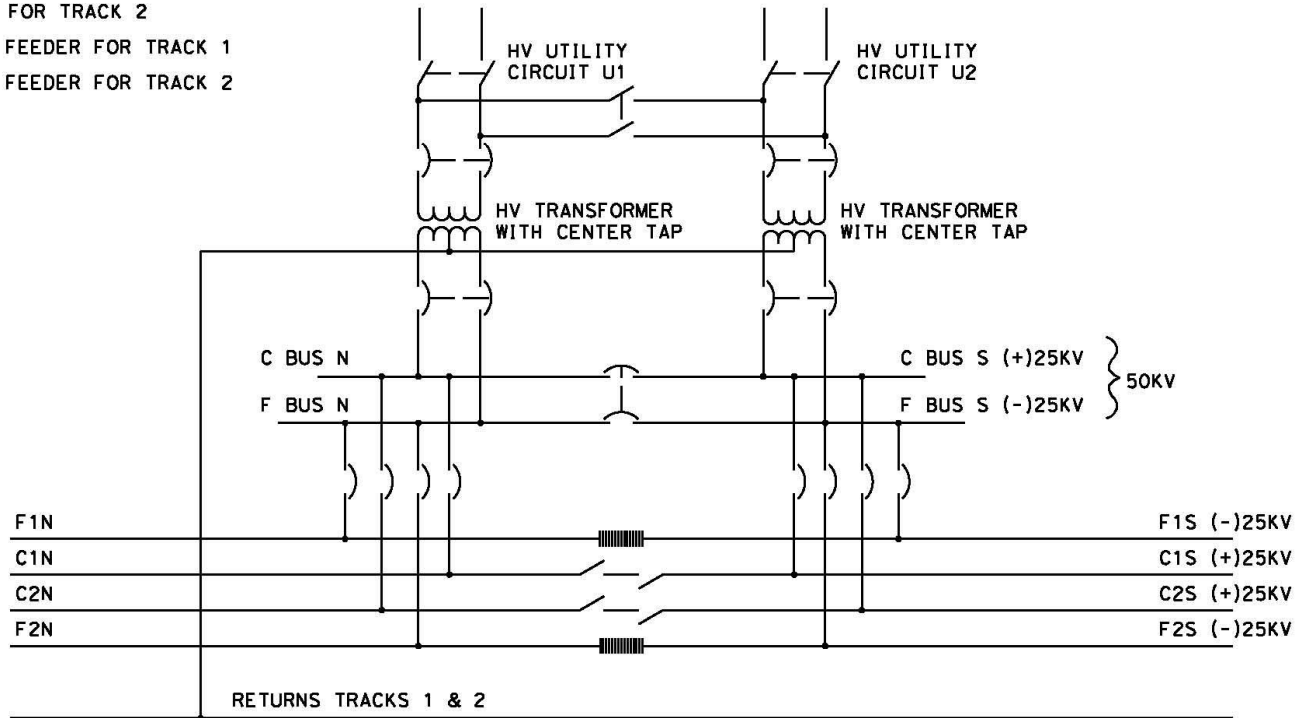

TRACTION POWER SUBSTATION WITH UTILITY SUPPLY - 2X25KV AUTOTRANSFORMER FEED SYSTEM

FIGURE 2

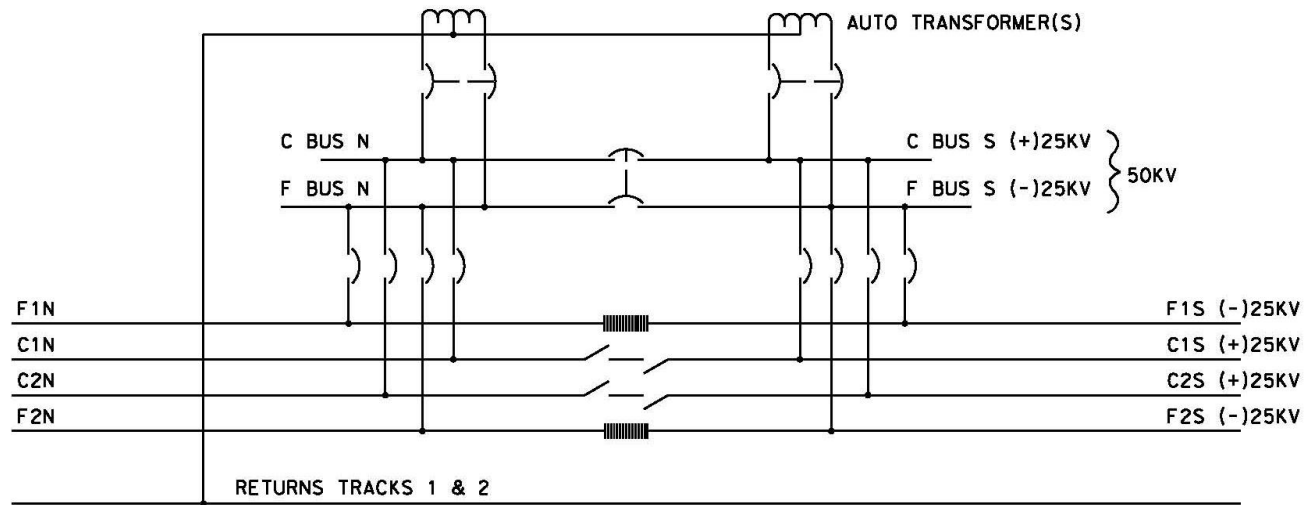

SWITCHING STATION FOR 2X25KV AUTO TRANSFORMER FEED SYSTEM

FIGURE 3

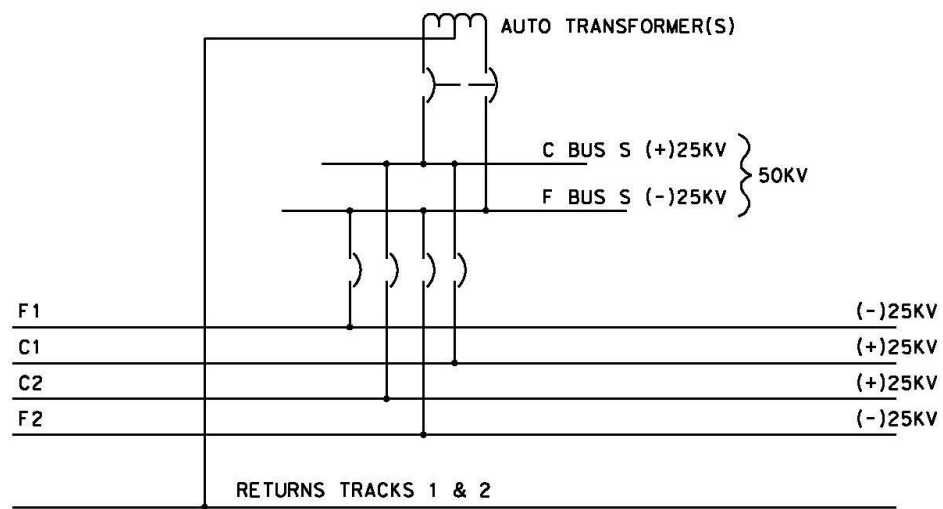

PARALLELING STATION FOR 2X25KV AUTO TRANSFORMER FEED SYSTEM

FIGURE 4

U = HV UTILITY SUPPLY
 PS = PARALLELING (AUTO-TRANSFORMER) STATION
 (30) = APPROXIMATE DISTANCE IN MILES
 MVA = APPROXIMATE TRANSFORMER RATING

NOTE: DISTANCES AND RATINGS SHOWN ARE FOR COMPARISON AND PLANNING PURPOSES ONLY

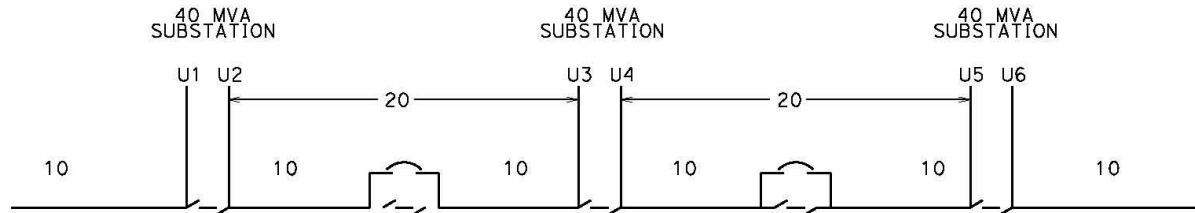

SIMPLIFIED FEEDING ARRANGEMENT 1X25KV SYSTEM

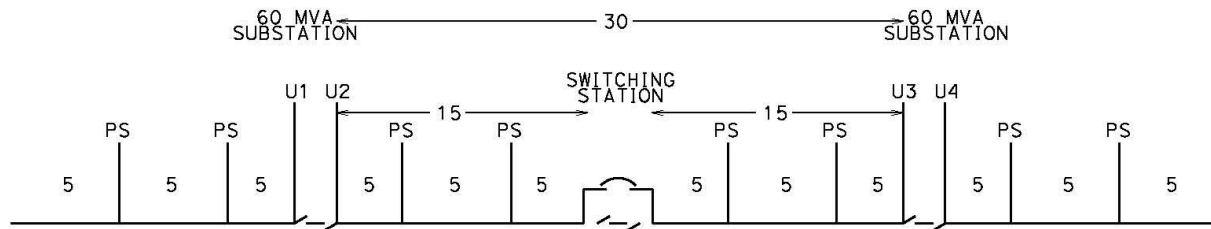

SIMPLIFIED FEEDING ARRANGEMENT
 2X25KV AUTOTRANSFORMER FEED SYSTEM

FIGURE 5

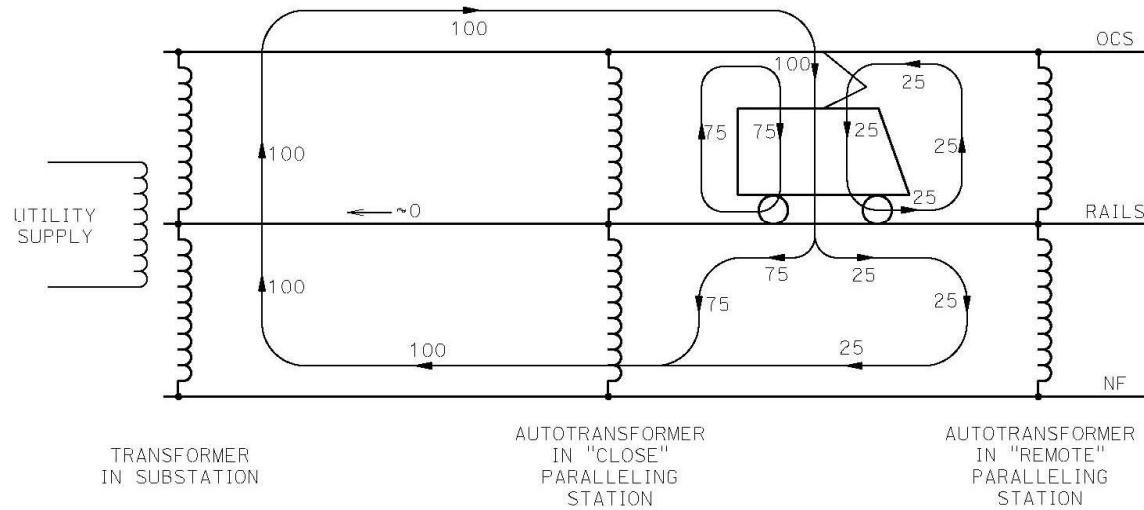

2X25KV AUTOTRANSFORMER FEED SYSTEM:
TYPICAL PROPORTIONAL CURRENT DISTRIBUTION FOR TRAIN LOAD OF 200A

FIGURE 6

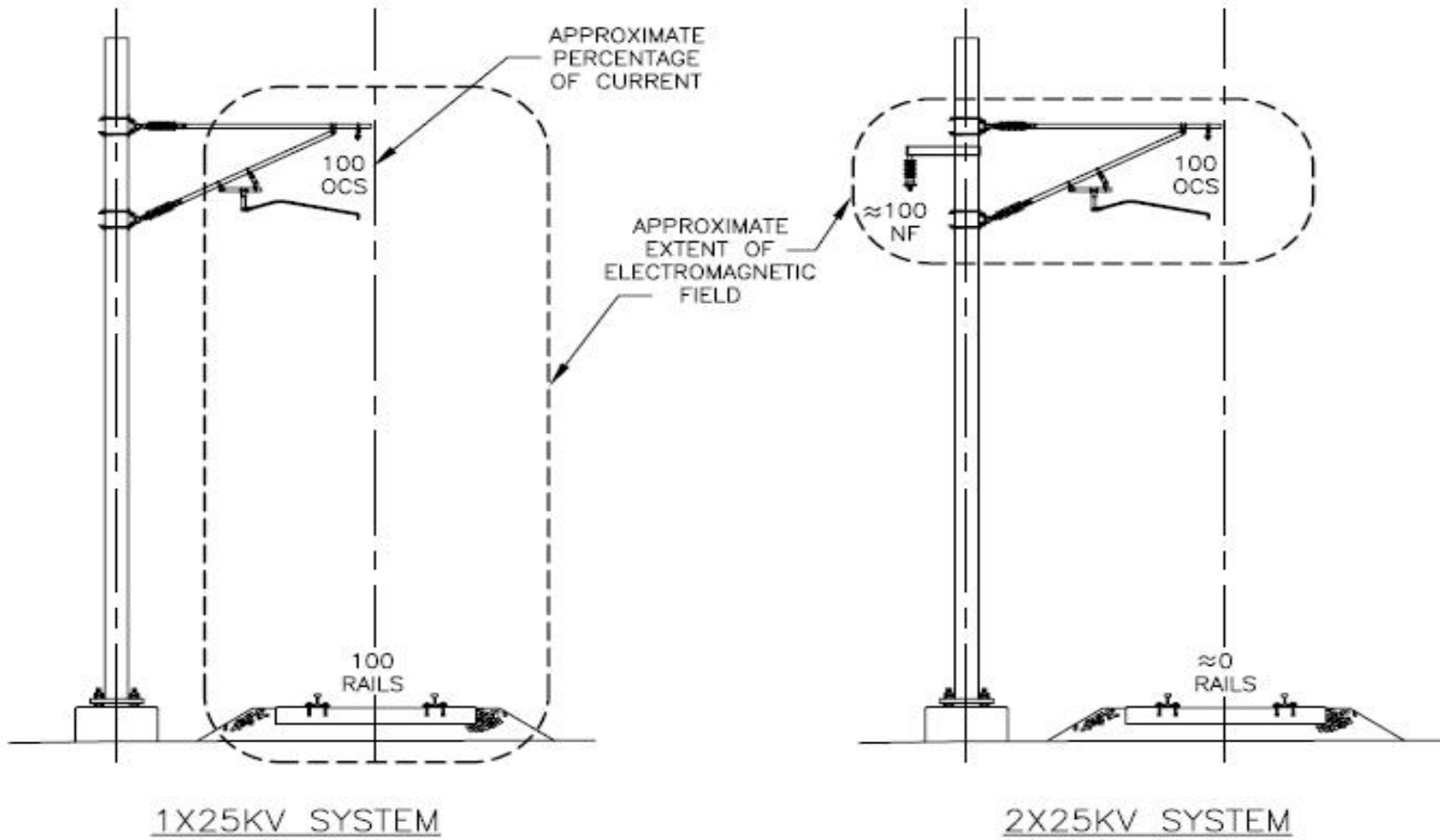

SIMPLIFIED COMPARISON OF EXTENT OF ELECTROMAGNETIC FIELD FOR 1X25KV AND 2X25KV SYSTEMS

FIGURE 7